



# INSTALLATION, OPERATING & MAINTENANCE INSTRUCTIONS

## VERTICAL MODELS LV / LS



# TABLE OF CONTENTS

PRODUCT SAFETY	2
RECEIVING	2
INSTALLATION	3
NORMAL PIPING PRACTICE	3
START-UP	4
FAN COIL PIPING INSTRUCTIONS	5
WILLIAMS ONDemand™ INSTRUCTIONS	7
MAINTENANCE / REPAIR INTRODUCTION	11
REPLACEMENT PARTS INSTRUCTIONS	12
MAINTENANCE / REPAIR LOG	13
FILTER REPLACEMENT LOG	14
CHECKLIST	15

## PRODUCT SAFETY

### *IMPORTANT INFORMATION ABOUT SAFETY INSTRUCTIONS*

The Important Safety Instructions and warnings in these instructions are not meant to cover all possible problems and conditions that can occur. Use common sense and caution when installing, maintaining or operating the equipment.

Always contact the Williams Applied Support Team about any problems or conditions that you do not understand.

### SAFETY SYMBOLS AND LABELS USED IN THESE INSTRUCTIONS



**WARNING:** Hazards or unsafe practices that COULD result in severe personal injury or death.



**CAUTION:** Hazards or unsafe practices that COULD result in minor personal injury or property damage.

## RECEIVING

Upon delivery, examine each unit carefully for shipping damage. Immediately report any freight damage to the freight carrier and file a freight claim with the carrier. All units are shipped FOB factory; therefore Williams is not responsible for damage during transit.

It is the responsibility of the installing contractor to inspect and verify that the unit received is the correct model number, voltage, etc. Any discrepancies should be resolved before uncrating and/or installation. **Williams is not responsible for any back charges due to an incorrect unit being installed.**

Returns require written authorization from Williams. Unauthorized returns will be refused. All material returned will be inspected. Any damage, missing parts, rework or repackaging resulting from prior installation, abuses or neglect will constitute just cause for Williams to issue partial credit.

# INSTALLATION

Prior to installation check to make sure unit is as ordered and that the fan rotates freely. This unit must be installed in a manner which will allow the blower access panel to be removed in order to clean the coil surface, blower, or motor. When installed in a concealed building space acting as return-air plenum, the installation must conform to the requirements of NFPA Standard 90B. It must be installed level and condensate drain lines must be trapped with proper slope for rapid drainage. Water and drain connections must be made to the unit in accordance with local codes.

 **CAUTION:** It is the sole responsibility of the customer to provide the necessary protection to prevent vandalism and weather protection of the equipment. Under no circumstance should the fan coil be left exposed to the elements. Protect the units from dirt, plaster and other debris during the entire construction phase. Prior to start-up, the entire interior of the unit should be inspected for debris and dirt. Clean, if necessary. Any failure of the unit or damage to the building as a result of improperly protecting and cleaning the unit is not covered by the warranty.

 **WARNING:** These units weigh 110-290 lbs., a minimum of two people are recommended for handling and installation.

# NORMAL PIPING PRACTICE

The bottom coil connection, on the leaving-air-side, is the water supply inlet. All piping must be supported independently from the coil to prevent damage to the soldered joints. Chilled water and condensate drain lines must be insulated for efficient operation and to prevent condensate formation. Pipe insulation must be closed-cell or have a vapor barrier. All joints must be properly sealed against air leaks to the piping. Control valves, shut-off valves, and uninsulated water piping must be installed over the drain pan or utilize an accessory drain pan extension. Condensate lines, one primary and one secondary, must be properly pitched to the building drain. Williams will not assume any liability for damage caused as a result of the condensate drain line not being properly pitched or trapped. The use of a secondary drain pan under the entire unit, with a separate drain line, is advised in areas where water damage is very critical. See the Fan Coil Piping Instructions on Page 5.

 **WARNING:** If the unit is installed during the winter months, care must be taken so that the unit is not subject to freezing temperatures while filled with water during construction. Coils damaged due to freezing are not covered by the warranty. Williams' fan coil units are suitable for zero clearance to combustible material. All air must be bled out of the water system. Any air trapped in the hot or chilled water coil can be released from the system by using the manual air vent on the coil.

For hot and humid areas: Do not operate during construction or renovation with windows and doors open causing outside air to enter the building. When the outside air enters the building, it imposes high cooling and dehumidifying loads on the units.

# START-UP

After the fan coil and piping have been installed, pressure test for 24 hours with a minimum of 2½ times the working pressure to insure that there are no leaks in the system. This test should be performed prior to hanging or installation of ceilings, floor coverings, drapes, etc. Any damage caused due to leaks is not covered under the warranty.

## WIRING

The motor must be properly wired prior to start-up. The Wiring diagrams are provided with each unit and/or are part of the job submittals. The warranty on all motors is void if the motor is burned out due to incorrect wiring. Wire used for connections to the fan coil must be rated for at least 90° degrees centigrade. All wiring connections must be tight. Check the rating of the unit to determine: volts, hertz, horsepower, phase, amps per motor, appropriate switching, maximum circuit fuse amps, and minimum circuit fuse amps. All wiring must be done in accordance with applicable local electrical codes and/or standards.

**⚠ WARNING: RISK OF ELECTRICAL SHOCK. CAN CAUSE INJURY OR DEATH.** Disconnect all remote electric power supplies before servicing. Placing the thermostat in the "OFF" position should not be used for disconnect purposes.

## VARIABLE FAN COILS (COMFORTRAC AND TRACVALVE):

Since the variable fan coil is Leaving Air Temperature (LAT) controlled and has variable valves, the start-up procedure/verification is vastly simplified compared to standard fan coils.

All that is required is that you determine that the leaving air temperature falls within the specified range. Allow the unit to run for about 10 minutes and then measure the leaving air temperature to determine the temperature of the air at the unit, not necessarily where it enters the room. The set point is 58°F for cold and 96°F for hot. As long as the temperature is close to these temperatures, unit is functioning per design.

If for any reason you need to remove these actuators, follow these steps outlined here in making sure you have the valve actuator placed in the correct position.

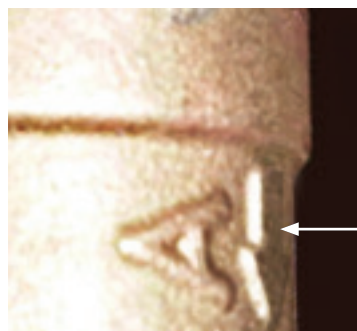

WATER  
DIRECTION  
ARROW

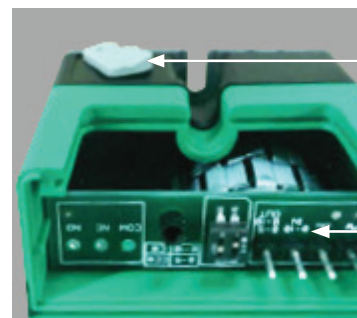

GRAY  
RELEASE  
LEVER

2 DIP  
SWITCHES

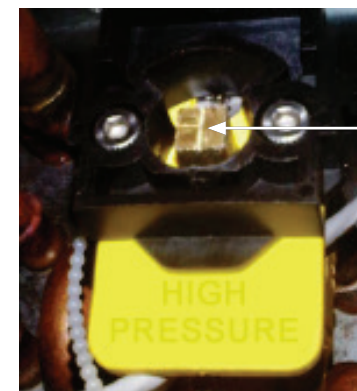

VALVE STEM  
MARKING



BLACK  
LEVER

# FAN COIL PIPING INSTRUCTIONS



**WARNING:** Failure to follow these instructions exactly when replacing the actuator valve may create a misalignment of the valve, resulting in leaking and subsequent property damage.

1. Be sure the long line on the Valve Stem Marking runs parallel to the water flow. The small intersecting line will be aimed toward the Water Direction Arrow.
2. The large black lever should be parallel to the long line on the Valve Stem Marking as shown. If not, pivot the gray Release Lever and while pivoted, turn the large black lever accordingly.
3. Set both dip switches in the position toward the black lever.
4. Place the green actuator assembly onto the valve and re-insert the pins.

## CHILLED AND HOT WATER COILS

### PURPOSE

This data is intended to explain piping arrangements for chilled and hot water coils to the correct inlet and outlet locations.

### TWO-PIPE COILS

Two pipe coils have one inlet and outlet. Fan coils may have one to six rows. The coil may be 100% chilled water, 100% hot water, or with the addition of a pipe sensor changeover control, it may use chilled water when the chiller is operating or hot water when the boiler is operating. A two-pipe system allows for the chiller or boiler to operate independently, one at a time. The pipe sensor must be clamped onto the supply water line as close to the incoming water source as possible. The purpose of the pipe sensor is to sense the water temperature in the inlet pipe and detect the water temperature at its set point of approximately 88°F. The pipe sensor will change the thermostat control from the cooling mode to the heating mode and vice versa.

The inlet is always at the bottom of the coil and the outlet is always at the top of the coil. All coils are piped so that the inlet is always on the row farthest downstream from the incoming air (See diagram 1).

All coils have one or more circuits. Circuits are added to reduce the water pressure drop to an acceptable level (usually 10-ft. H<sub>2</sub>O pressure drop or less). Due to the various circuit options available, the inlet, and outlet may change position making the inlet and outlet locations vary.

### FOUR-PIPE COILS

Four pipe coils have a dedicated, chilled water coil, and a dedicated hot water coil, each with its' own inlet and outlet, equaling four pipes. All coils have a common tube sheet for four pipe coils. Example: A four row, chilled water coil and a one row, hot water coil would use a five row coil with four rows for chilled water and one row for hot water. Normally the one row, hot water coil is in the reheat position or downstream from the cooling coil. The hot water coil may also be ordered in the preheat position or

upstream from the chilled water coil. The controls are wired so that either the chilled water coil is operating or the hot-water coil is operating, but not both at the same time. When the conditioned space thermostat is satisfied, both the chilled and hot water control valves are deactivated. The same rule applies for inlet and outlet locations as explained above in "Two Pipe Coils" (See diagram 2). Each chilled and hot water coil is controlled individually so a pipe sensor is not required.

**HOSE KITS**

When hose kits are being used on units it is important to make sure the hoses are not installed over any electrical components, such as j-boxes, actuators, etc. Hoses are not sweat proof so they can condensate. It is recommended that the flex hoses be field insulated during installation. Before installing flex hose visually examine the metallic sealing surface and verify it is flat and smooth with no sharp edges or deep scratches. Verify that the sealing gasket is properly installed/ inserted onto the end of the hose. When installing threaded union connection do not over tighten, this may cause damage to the gasket seal or sealing surface and subsequently leak at joint. Proper hose installation

practice is to had tighten the union, then use wrench to further tighten no more than a 1/4 turn. Do not apply pipe dope or thread sealant to sealing surface or pipe threads. Ensure the joints are leak free before starting up unit. If leak is observed slightly tighten the fitting not exceeding an additional 1/4 turn. Failure to follow these directions may cause unit leak or operation failure.

**WILLIAMS MODEL IDENTIFICATION**

The following model numbers indicate the number of rows and type of chilled and hot water coils. Williams standard coil has the hot water coil located in the reheat position.

- LV008**W2**B40 = **W2** indicates a two pipe water coil
- LV008**W4**B40 = **W4** indicates a four pipe water coil
- LV008W2B**40** = **40** indicates four row, chilled water; 0 row hot water (first digit=chilled water, second digit=hot water)
- LV008W4B**42** = **42** indicates four row, chilled water; 2 row hot water
- LV008W2B**02** = **02** indicates 0 row, chilled water row hot water (heating unit only)

**TWO PIPE COIL DIAGRAMS - 2 PIPE COILS (RIGHT HAND SHOWN LEFT HAND OPPOSITE)**

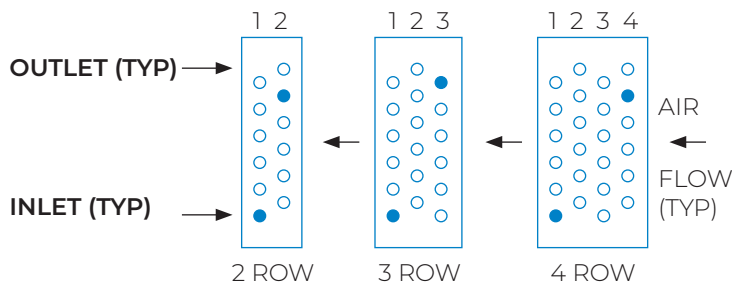

**FOUR PIPE COIL DIAGRAMS - 4 PIPE COILS (RIGHT HAND SHOWN LEFT HAND OPPOSITE)**

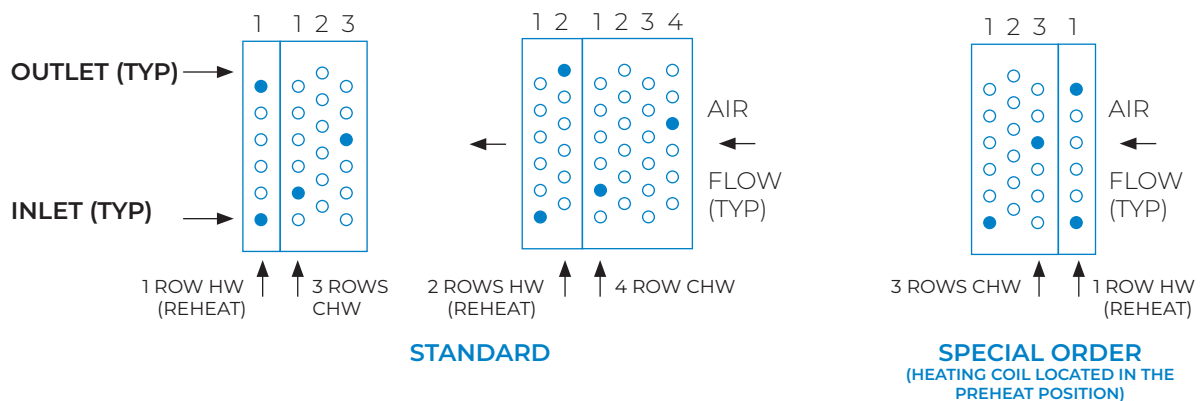

# WILLIAMS ONDemand™ INSTRUCTIONS

**ONDemand SYSTEMS** consist of a one pipe primary loop (or loops) and decoupled terminal unit circuits.

## FIGURE 1

ASHRAE describes this as a series circuit with compound pumping\*.

**DECOUPLED** is defined as “separated, disconnected, or divergent”. In hydronic systems, decoupling is the act of separating the effects of the flows in two piping loops that share a common pipe, often called a decoupler. For example, the secondary circuit in a primary/secondary system is decoupled from the primary loop such that the flow in the primary does not cause any flow in the secondary loop unless the secondary circulator is operated. The advantage of

decoupling in a ONDemand system is the ability to independently control flows in the terminal units without the need for control valves or balancing valves.

## FIGURE 2

Decoupling is illustrated below. Primary flow entering the tee at point A can follow one or two paths to get to point B. Since water always follows the path of least resistance, all the water will follow the path through the decoupler as long as its pressure drop is zero.

Due to the hydraulic separation caused by decoupling, purging and venting the air from ONDemand systems differs from typical two and four pipe systems using control valves. Following are descriptions of the best ways to install and purge ONDemand piping networks.

FIGURE 1

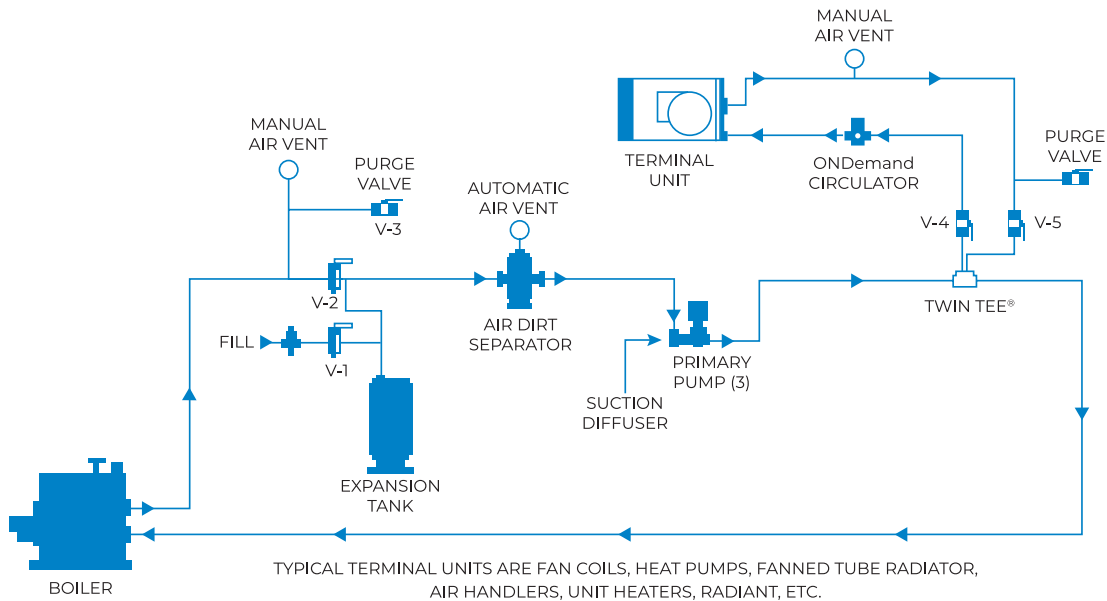
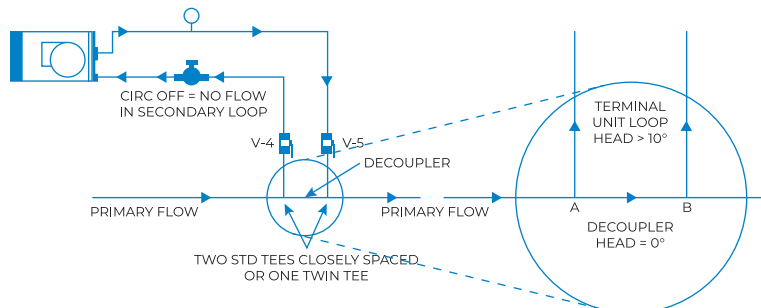

FIGURE 2



## ONDemand™ CIRCULATOR AND ORIENTATION

### FIGURE 3

The best location for a ONDemand circulator in the ONDemand loop is between the primary loop and the inlet side of the terminal unit.

### FIGURE 4

ONDemand circulators are supplied with spring loaded flow checks, located in the discharge, that only allow flow in one direction.

ONDemand circulators require system fluid, typically water or antifreeze solution, for cooling and lubricating. They must be purged and primed with clean fluid and not allowed to run dry.

As a result, circulators located after the purge valve, usually on the outlet or return side of the terminal unit, have the potential to trap air in the circulator because the flo-chek prevents water from flowing backwards through the circulator to the vent to

remove the air in the return line. Circulators must be installed upstream of the purge valve/manual air vent to avoid trapping air at the impellers.

All ONDemand circulators should be installed so the motor shaft is parallel to the ground and the junction box is not below the motor. Avoid installing a ONDemand circulator with the motor shaft vertical and the motor above the pipe/volute as air binding in the cartridge may prevent the cartridge from being adequately cooled and lubricated.

Purge valves and air vents are ideally located on the outlet side of the terminal unit.

Service valves (V-4 and V-5) should be close to the primary loop and close enough together to handle simultaneously, thus avoiding opening/closing the wrong valve(s) during purge process.

FIGURE 3

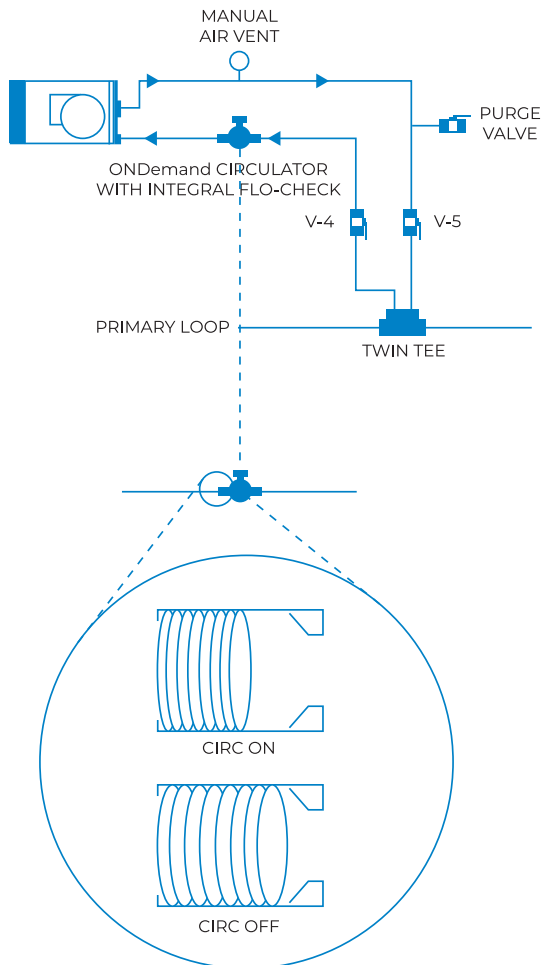
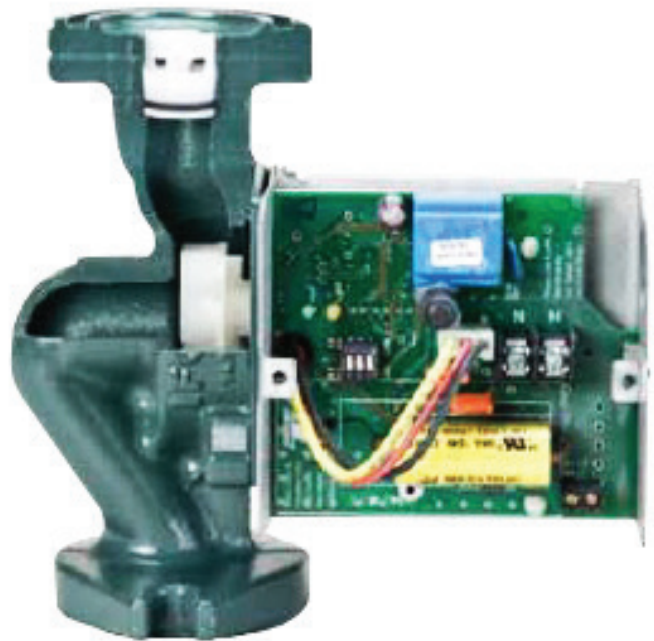

FIGURE 4





## TWIN TEE® LOCATION AND ORIENTATION

Twin Tees should be piped in the primary loop to minimize the length and complexity of the ONDemand loops. This will simplify the venting and purging of the ONDemand loops during startup.

To reduce the possibility of air and dirt entering the ONDemand loops from the primary loop, the Twin Tees should be oriented with the branch connections on the side as shown below.

### FIGURE 5

Twin Tees can be installed with flow going through them in either direction. Branch connections are also independent of flow direction. Either outlet can be used for supply or return.

There is no minimum distance required between multiple Twin Tees installed in the same loop. Due to the relatively high flow rate in the primary loop compared to the Load-Match loop, there is little chance the flows in one Twin Tee will affect another.

It is acceptable to connect more than one terminal unit to a Twin Tee provided the piping can be kept relatively short and excessive fittings avoided. When in doubt, dedicate a separate Twin Tee to each terminal unit.  
FIGURE 5



### FIGURE 6

In lieu of a Twin Tee, two standard tee fittings can be used to connect any ONDemand loop to the primary loop. In this case, the tees should be joined end to end with a close or space coupling so they are as close together as possible. In this arrangement, the upstream tee must be the supply to the terminal unit and the downstream tee the return.

FIGURE 6

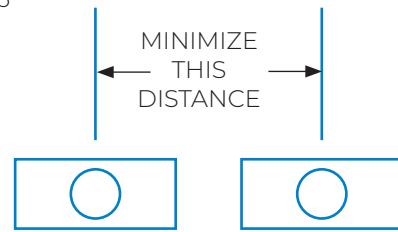

## PURGING AND CLEANING PRIMARY LOOP(S)

Purge and clean primary loop(s) first with valves on ONDemand loops closed and all pumps and Load-Match circulators OFF.

To prevent pipe shavings and other debris from fouling the flo-checks in the ONDemand circs and/or coils in the terminal units (particularly heat pumps), the primary loop should be thoroughly cleaned and flushed before opening valves on ONDemand loops. This is consistent with industry standard heat pump system purging and cleaning processes.

### FIGURE 7

Purging the primary loop is best accomplished using higher city water pressure instead of the pressure created by the primary pump(s). Close primary loop valve V-2, and open fill valve V-1 and purge valve V-3. City water pressure can now purge the entire loop out through V-3 without primary pump(s) running. Other air vents located throughout the piping network should also be utilized to eliminate isolated air pockets.

Once purged, the primary pump(s) can be started and the primary loop cleaned. Primary pump(s) should be operated until start up screens in suction diffusers no longer show signs of pipe shavings or debris and water blown down from air/ dirt separator is clean. In most cases, primary pump(s) may need to run for 24 hours or more and screens cleaned repeatedly.

If there are multiple boilers or chillers, make sure to alternate purging of boiler / chiller modules to be sure each is free of air and debris before leaving them open to the rest of the system.

Once the primary loop has been purged and cleaned, a similar process can be executed for the ONDemand secondary loops.

FIGURE 7

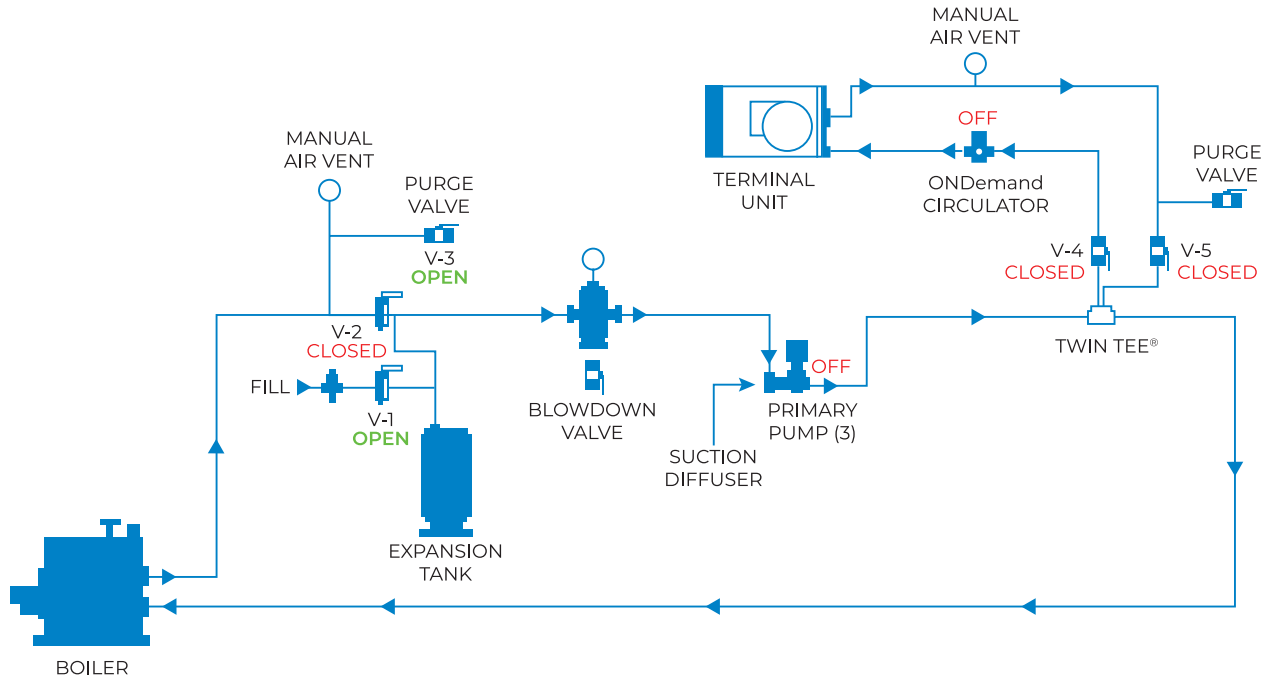
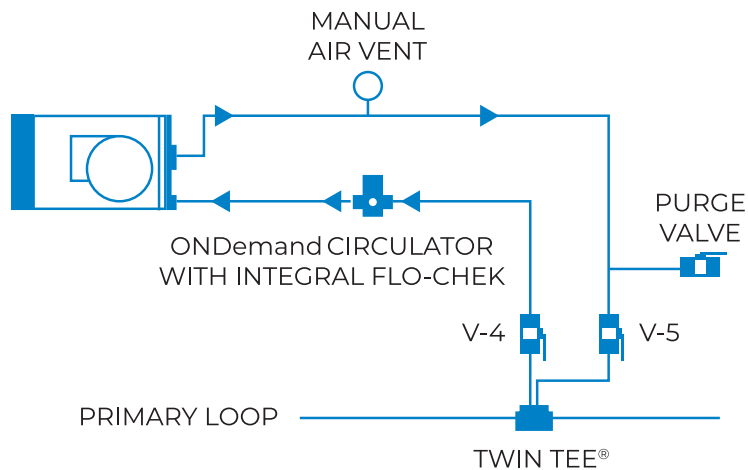

FIGURE 8



Purging and Cleaning ONDemand® Loop(s) City water pressure should also be used to purge the ONDemand loops instead of the pressure created by the ONDemand circulators. Primary pump(s) should be OFF, V-2 and V-3 closed and main fill valve V-1 should be open to maintain city water pressure in the clean primary loop.

**FIGURE 8**

To purge ONDemand loop, open supply valve to the terminal unit V-4 and close return valve V-5. Opening the manual air vent / purge valve will allow city water

pressure to purge air from the entire supply pipe, Load-Match circulator and terminal unit.

To purge the return side, close V-4 and open V-5 and open the manual air vent / purge valve until no more air is released. Both valves V-4 and V-5 can then be opened for normal operation.

If the ONDemand loop has a significant number of fittings, multiple changes in elevation or is longer than normal (i.e. 30 ft.), additional air vents should be located at the high points to eliminate isolated air pockets.

# MAINTENANCE / REPAIR INTRODUCTION

By nature, heating, ventilation and air conditioning equipment deteriorates with normal use. To help alleviate this, preventive maintenance is required. When properly maintained, the systems will experience improved efficiency and increased equipment life.

Failure to perform preventive maintenance of Williams equipment, by a licensed HVAC technician per the recommended schedule, will result in loss of factory warranty. Logs are provided in this manual and are to be filled out documenting all repairs and maintenance performed.

## PREVENTIVE MAINTENANCE

### GENERAL (ANNUALLY)

- Visual Inspection for corrosion and proper mounting, alignment and sealing
  - Installation of unit
  - Air Connections
  - Water connections
  - Condensate drainage pitch
- Functional Inspection of operation
  - Heating mode
  - Cooling mode
  - Amperage draw
  - Supply voltage

### COILS (ANNUALLY)

- Clean the coils by removing the blower panel and brushing the fins with a stiff, plastic bristle brush, taking care not to bend or damage the fin surface. After brushing, the coil should be vacuumed to remove loose dirt.
- Check insulation for proper coverage to maintain efficiency and prevent sweating.
- Piping – inspect all connections for leaks and corrosion.
- Valves – Check for proper operation, corrosion and leaking.

### MOTOR (ANNUALLY)

- **If there are no oil tubes present, the motor is permanently lubricated.**
- If oil tubes are provided on the motor, lubricate every six months with SAE-10 weight,

non-detergent oil. Inspect the motor and blower assembly every time the motors are oiled for excessive accumulation of dust and dirt. If necessary, remove the blower and vacuum. If this situation does occur, increase routine filter maintenance. **“DO NOT OVER OIL”**

- Check amperage draw against the nameplate information
- Check bearings for wear and noise.
- Wheel – Check for free spinning movement
- Check for tightness of set screws.
- Check blades for damages.

### DRAIN PAN (ANNUALLY)

- The drain pan must be inspected before summer operation. All debris in the drain pan should be removed so the condensate will flow out easily. Periodic inspection of the drain pan and condensate piping should be performed during the summer operation to prevent any possibility of it becoming clogged. Williams will assume no liability for damage caused as a result of the condensate line becoming plugged.
- Corrosion – Check for signs of rust; heavy flake indicate that replacement is needed.
- Float Switch – The optional drain pan float switch position is not adjustable. The float switch must be mounted flush with the edge of the drain pan for optimum performance. Any attempt in moving the float switch in any other position can result in unit failure.
- P-trap and Piping – be sure these areas are free of debris that could block drainage.
- Drainage – test functionality by pouring water into the pan and observing proper operation.



### **WARNING: RISK OF ELECTRICAL SHOCK. CAN CAUSE INJURY OR DEATH.**

Disconnect all remote electric power supplies before servicing. Placing the thermostat in the “OFF” position should not be used for disconnect purposes.

### ELECTRICAL (ANNUALLY)

- Inspect for signs of arcing or overheated wires.
- Check ground connection for signs of corrosion.

- Check all connections for a tight fit.

#### **FILTERS (6 MONTHS)**

- Disposable - Change throwaway filters a minimum of twice a year and recorded on the Filter Replacement Log. Once before the heating season and once before the cooling season. Periodic checks should be made during the cooling season to insure that excessive dust or lint is not accumulating to the extent of interrupting free air flow. If excessive dirt accumulates, the filter should be changed more frequently.

- Reusable/Cleanable - Filters should be thoroughly cleaned a minimum of twice a year and have the same periodic checks as throwaway filters.

#### **HOSES, IF EQUIPPED (ANNUALLY)**

- Check all fittings for leaks.
- Check for frayed braiding

#### **REPLACEMENT PARTS**

- It is strongly recommended that genuine Williams parts be used when replacement is required. When ordering replacement parts, refer to the model and serial number located on the blower and motor housing.

---

# REPLACEMENT PARTS INSTRUCTIONS

When ordering replacement parts, refer to the model and serial number located on the blower and motor housing.





# CHECKLIST

<b>RECEIVING &amp; INSPECTION</b>		✓
1	Unit received undamaged	
2	Unit received complete as ordered	
3	Parts accounted for	
4	Unit arrangement/hand correct	
5	Unit structural support complete & correct	
<b>HANDLING &amp; INSTALLATION</b>		✓
6	Mounting grommets / isolators used	
7	Unit mounted level & square	
8	Proper access provided for unit & accessories	
9	Proper electrical service provided	
10	Proper over current protection provided	
11	Proper service switch / disconnect provided	
12	Proper chilled water line size to unit	
13	Proper hot water line size to unit	
14	Proper refrigerant line size to unit	
15	Proper steam line sizes to unit	
16	Proper steam condensate trap on return line	
17	Proper steam supply pressure to unit (15 PSI max)	
18	All services to unit in code compliance	
19	All shipping screws & brace removed	
20	Unit protected from dirt & foreign matter	
21	Filter is clean & free of construction debris	
<b>COOLING / HEATING CONNECTIONS</b>		✓
22	Protect valve package components from heat	
23	Mount / check valve packages	
24	Connect field piping to unit	
25	Pressure test all piping for leaks	
26	Install drain line & traps as required	
27	Insulate all piping as required	
28	Install drip lip under piping as required	
29	Expansion joint for risers assembly if required, Properly anchored	
30	Drain line properly sloped & not clogged	
31	Modulating valve properly calibrated	

<b>DUCTWORK CONNECTIONS</b>		✓
32	Install ductwork, fittings & grilles as required	
33	Flexible duct connections at unit	
34	Proper supply and return grille type & size used	
35	Control outside air for low / high limit protection	
36	Insulate all ductwork & dampers as required	
<b>ELECTRICAL CONNECTIONS</b>		✓
37	Refer to unit wiring diagram	
38	Connect incoming power service(s)	
39	Install & connect parts	
40	All field wiring with proper gauge & in code compliance	
<b>UNIT STARTUP</b>		
41	General visual unit & system inspection	
42	Check for proper fan belt tension	
43	Check for proper fan rotation	
44	Record electrical supply voltage	
45	Record ambient temperatures	
46	Check all wiring for secure connections	
47	Close all unit isolation valves	
48	Flush water systems	
49	Fill systems with water / refrigerant	
50	Vent water systems as required	
51	All ductwork & grilles in place	
52	All unit panels and filters in place	
53	Start fans, pumps, chillers, etc.	
54	Check for overload conditions of all units	
55	Check all duct works & units for air leaks	
56	Balance air systems as required	
57	Record all final settings for future use	
58	Balance water systems as required	
59	Record all final settings for future use	
60	Check piping & ductwork for vibration	
61	Check all dampers for proper operation	
62	Verify proper cooling operation	
63	Verify proper heating operation	
64	Reinstall all covers & access panel	



WWW.WFC-FC.COM | 888-444-1212  
250 West Laurel Street, Colton, CA 92324 USA



DESIGNED  
& ASSEMBLED  
IN THE USA  
SINCE 1916